

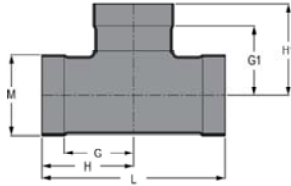

Tee

Belled Socket



Part Number		Size	G	G1	H	H1	L	M
PVC	CPVC							
4301-060	4301-060C	6	6	6-1/8	8-1/2	8-5/8	17	7
4301-080	4301-080C	8	7	7-1/8	9-1/2	9-5/8	19	9
4301-100	4301-100C	10	8	8-11/16	10-1/2	11-3/16	21	11-1/8
4301-120	4301-120C	12	9-1/16	9-11/16	11-9/16	12-3/16	23-1/8	13-1/8
4301-140	4301-140C	14	11-3/8	10-13/16	13-7/8	13-5/16	27-3/4	14-3/8
4301-160	4301-160C	16	12-3/8	11-13/16	14-7/8	14-5/16	29-3/4	16-3/8
4301-180	4301-180C	18	13-3/8	12-13/16	15-7/8	15-5/16	31-3/4	18-3/8
4301-200	4301-200C	20	14-3/8	13-3/4	16-7/8	16-1/4	33-3/4	20-7/16
4301-240	4301-240C	24	16-3/4	16-1/2	19-1/4	19	38-1/2	24-1/2

Tee, Reducing

Belled Socket

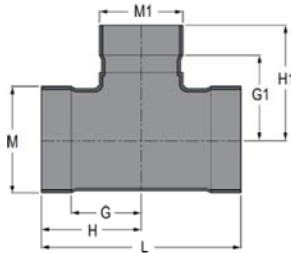

Part Number		Size	G	G1	H	H1	L	M	M1
PVC	CPVC								
4301-532	4301-532C	6X4	5	6-7/16	7-1/2	8-15/16	15	7	5
4301-582	4301-582C	8X4	5	7-7/16	7-1/2	9-15/16	15	9	5
4301-585	4301-585C	8X6	6	7-1/8	8-1/2	9-5/8	17	9	7
4301-624	4301-624C	10X4	5	8-1/2	7-1/2	11	15	11-1/8	5
4301-626	4301-626C	10X6	6	8-3/16	8-1/2	10-11/16	17	11-1/8	7
4301-628	4301-628C	10X8	7	8-3/16	9-1/2	10-11/16	19	11-1/8	9
4301-664	4301-664C	12X4	5	9-1/2	7-1/2	12	15	13-1/8	5
4301-666	4301-666C	12X6	6	9-3/16	8-1/2	11-11/16	17	13-1/8	7
4301-668	4301-668C	12X8	7	9-3/16	9-1/2	11-11/16	19	13-1/8	9
4301-670	4301-670C	12X10	8	9-11/16	10-1/2	12-3/16	21	13-1/8	11-1/8
4301-694	4301-694C	14X4	6-5/8	11-1/8	9-1/8	13-5/8	18-1/4	14-3/8	5
4301-696	4301-696C	14X6	7-5/8	10-13/16	10-1/8	13-5/16	20-1/4	14-3/8	7
4301-698	4301-698C	14X8	8-5/8	10-13/16	11-1/8	13-5/16	22-1/4	14-3/8	9
4301-700	4301-700C	14X10	9-3/4	10-13/16	12-1/4	13-5/16	24-1/2	14-3/8	11-1/8
4301-702	4301-702C	14X12	10-3/4	10-13/16	13-1/4	13-5/16	26-1/2	14-3/8	13-1/8
4301-754	4301-754C	16X4	6-5/8	12-1/8	9-1/8	14-5/8	18-1/4	16-3/8	5
4301-756	4301-756C	16X6	7-5/8	11-13/16	10-1/8	14-5/16	20-1/4	16-3/8	7
4301-758	4301-758C	16X8	8-5/8	11-13/16	11-1/8	14-5/16	22-1/4	16-3/8	9
4301-760	4301-760C	16X10	9-3/4	11-13/16	12-1/4	14-5/16	24-1/4	16-3/8	11-1/8
4301-762	4301-762C	16X12	10-3/4	11-13/16	13-1/4	14-5/16	26-1/2	16-3/8	13-1/8



Duct - Fume & Air Technical Technical Information

Tee, Reducing

Belled Socket

(Continued)

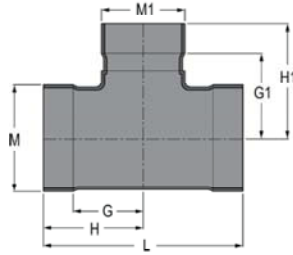

Part Number		Size	G	G1	H	H1	L	M	M1
PVC	CPVC								
4301-764	4301-764C	16X14	11-3/8	11-13/16	13-7/8	14-5/16	27-3/4	16-3/8	14-3/8
4301-784	4301-784C	18X4	6-5/8	13-1/8	9-1/8	15-5/8	18-1/4	18-3/8	5
4301-786	4301-786C	18X6	7-5/8	12-13/16	10-1/8	15-5/16	20-1/4	18-3/8	7
4301-788	4301-788C	18X8	8-5/8	12-13/16	11-1/8	15-5/16	22-1/4	18-3/8	9
4301-790	4301-790C	18X10	9-3/4	12-13/16	12-1/4	15-5/16	24-1/2	18-3/8	11-1/8
4301-792	4301-792C	18X12	10-3/4	12-13/16	13-1/4	15-5/16	26-1/2	18-3/8	13-1/8
4301-794	4301-794C	18X14	11-3/8	12-13/16	13-7/8	15-5/16	27-3/4	18-3/8	14-3/8
4301-796	4301-796C	18X16	12-3/8	12-13/16	14-7/8	15-5/16	29-3/4	18-3/8	16-3/8
4301-814	4301-814C	20X4	6-5/8	14-1/16	9-1/8	16-9/16	18-1/4	20-7/16	5
4301-816	4301-816C	20X6	7-5/8	13-3/4	10-1/8	16-1/4	20-1/4	20-7/16	7
4301-818	4301-818C	20X8	8-5/8	13-3/4	11-1/8	16-1/4	22-1/4	20-7/16	9
4301-820	4301-820C	20X10	9-3/4	13-3/4	12-1/4	16-1/4	24-1/2	20-7/16	11-1/8
4301-822	4301-822C	20X12	10-3/4	13-3/4	13-1/4	16-1/4	26-1/2	20-7/16	13-1/8
4301-824	4301-824C	20X14	11-3/8	13-3/4	13-7/8	16-1/4	27-3/4	20-7/16	14-3/8
4301-826	4301-826C	20X16	12-3/8	13-3/4	14-7/8	16-1/4	29-3/4	20-7/16	16-3/8
4301-828	4301-828C	20X18	13-3/8	13-3/4	15-7/8	16-1/4	31-3/4	20-7/16	18-3/8
4301-904	4301-904C	24X4	6-5/8	16-1/16	9-1/8	18-9/16	18-1/4	24-1/2	5
4301-906	4301-906C	24X6	7-5/8	15-3/4	10-1/8	18-1/4	20-1/4	24-1/2	7
4301-908	4301-908C	24X8	8-5/8	15-3/4	11-1/8	18-1/4	22-1/4	24-1/2	9
4301-910	4301-910C	24X10	9-3/4	15-3/4	12-1/4	18-1/4	24-1/2	24-1/2	11-1/8
4301-912	4301-912C	24X12	10-3/4	15-3/4	13-1/4	18-1/4	26-1/2	24-1/2	13-1/8
4301-914	4301-914C	24X14	11-3/8	15-3/4	13-7/8	18-1/4	27-3/4	24-1/2	14-3/8
4301-916	4301-916C	24X16	12-3/8	15-3/4	14-7/8	18-1/4	29-3/4	24-1/2	16-3/8
4301-918	4301-918C	24X18	13-3/8	15-3/4	15-7/8	18-1/4	31-3/4	24-1/2	18-3/8
4301-920	4301-920C	24X20	14-3/8	15-3/4	16-7/8	18-1/4	33-3/4	24-1/2	20-7/16

90° Elbow

Belled Socket

General Purpose 2-Piece Construction

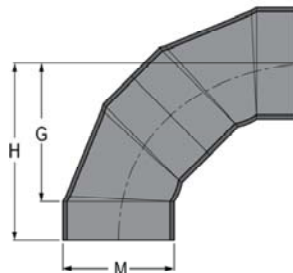

Part Number		Size	G	H	M
PVC	CPVC				
4306-060	4306-060C	6	8-5/16	10-13/16	7
4306-080	4306-080C	8	9-5/16	11-13/16	9
4306-100	4306-100C	10	10-3/8	12-7/8	11-1/8
4306-120	4306-120C	12	11-3/8	13-7/8	13-1/8



90° Elbow

Belled Socket
 General Purpose 2-Piece Construction

(Continued)

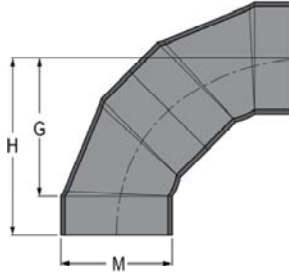

Part Number		Size	G	H	M
PVC	CPVC				
4306-140	4306-140C	14	12-11/16	15-3/16	14-3/8
4306-160	4306-160C	16	13-11/16	16-3/16	16-3/8
4306-180	4306-180C	18	14-11/16	17-3/16	18-3/8
4306-200	4306-200C	20	15-11/16	18-3/16	20-7/16
4306-240	4306-240C	24	17-3/4	20-1/4	24-1/2

90° Elbow 3-Piece

Belled Socket
 General Purpose 3-Piece Constructions

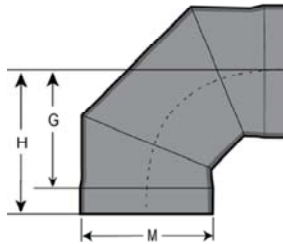

Part Number		Size	G	H	M
PVC	CPVC				
43063-060	43063-060C	6	6-15/16	9-7/16	7
43063-080	43063-080C	8	8-1/2	11	9
43063-100	43063-100C	10	10	12-1/2	11-1/8
43063-120	43063-120C	12	11-5/8	14-1/8	13-1/8
43063-140	43063-140C	14	13-1/8	15-5/8	14-3/8
43063-160	43063-160C	16	14-5/8	17-1/8	16-3/8
43063-180	43063-180C	18	16-1/4	18-3/4	18-3/8
43063-200	43063-200C	20	17-7/8	20-3/8	20-7/16
43063-240	43063-240C	24	21	23-1/2	24-1/2
43063-G26	43063-G26C	26	26	29	26-3/8
43063-280	43063-280C	28	28	31	28-3/8
43063-300	43063-300C	30	30	33	30-3/8
43063-320	43063-320C	32	32	35	32-3/8
43063-360	43063-360C	36	36	39	36-1/2



Duct - Fume & Air Technical Technical Information

90° Elbow - SMACNA 3-Piece

Belled Socket
SMACNA Compliant 3-Piece Construction

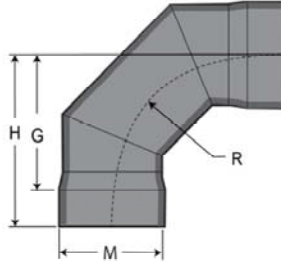

Part Number		Size	G	H	M	R
PVC	CPVC					
43063S-060	43063S-060C	6	9	11-1/2	7	9
43063S-080	43063S-080C	8	12	14-1/2	9	12
43063S-100	43063S-100C	10	15	17-1/2	11-1/8	15
43063S-120	43063S-120C	12	18	20-1/2	13-1/8	18
43063S-140	43063S-140C	14	21	23-1/2	14-3/8	21
43063S-160	43063S-160C	16	24	26-1/2	16-3/8	24

For Nominal Sizes 18" and Larger, use SMACNA 5-Piece Construction

90° Elbow - SMACNA 5-Piece

Belled Socket
SMACNA Compliant 5-Piece Construction

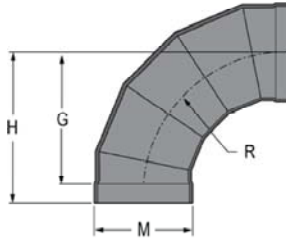

Part Number		Size	G	H	M	R
PVC	CPVC					
43065-060	43065-060C	6	9-7/8	12-3/8	7	9
43065-080	43065-080C	8	12-1/2	15	9	12
43065-100	43065-100C	10	15-1/16	17-9/16	11-1/8	15
43065-120	43065-120C	12	17-5/8	20-1/8	13-1/8	18
43065-140	43065-140C	14	20-1/8	22-5/8	14-3/8	21
43065-160	43065-160C	16	22-7/8	25-3/8	16-3/8	24
43065-180	43065-180C	18	25-7/16	27-15/16	18-3/8	27
43065-200	43065-200C	20	28	30-1/2	20-7/16	30
43065-240	43065-240C	24	33-1/2	36	24-1/2	36

45° Elbow

Belled Socket
General Purpose 1-piece Construction

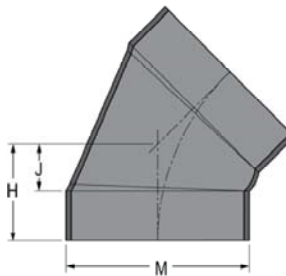

Part Number		Size	H	J	M
PVC	CPVC				
4317-060	4317-060C	6	4-1/2	2	7
4317-080	4317-080C	8	4-7/8	2-3/8	9



45° Elbow

Belled Socket
 General Purpose 1-piece Construction

(Continued)

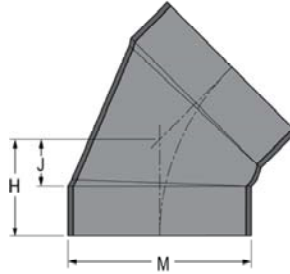

Part Number		Size	H	J	M
PVC	CPVC				
4317-100	4317-100C	10	5-3/8	2-7/8	11-1/8
4317-120	4317-120C	12	5-3/4	3-1/4	13-1/8
4317-140	4317-140C	14	6-5/16	3-13/16	14-3/8
4317-160	4317-160C	16	6-11/16	4-3/16	16-3/8
4317-180	4317-180C	18	7-1/8	4-5/8	18-3/8
4317-200	4317-200C	20	7-9/16	5-1/16	20-7/16
4317-240	4317-240C	24	8-3/8	5-7/8	24-1/2

45° Elbow - SMACNA 3-Piece

Belled Socket
 SMACNA Compliant 3-Piece Construction

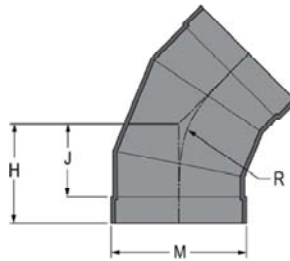

Part Number		Size	H	J	M	R
PVC	CPVC					
43173-060	43173-060C	6	7-1/8	4-5/8	7	9
43173-080	43173-080C	8	8	5-1/2	9	12
43173-100	43173-100C	10	8-13/16	6-5/16	11-1/8	15
43173-120	43173-120C	12	9-9/16	7-1/16	13-1/8	18
43173-140	43173-140C	14	10-5/16	7-13/16	14-3/8	21
43173-160	43173-160C	16	11-5/16	8-13/16	16-3/8	24
43173-180	43173-180C	18	12-1/8	9-5/8	18-3/8	27
43173-200	43173-200C	20	12-15/16	10-7/16	20-7/16	30
43173-240	43173-240C	24	14-7/8	12-3/8	24-1/2	36

Cross

Belled Socket

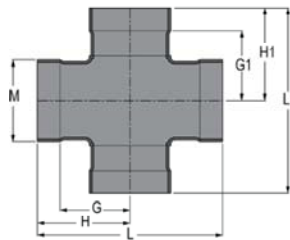

Part Number		Size	G	G1	H	H1	L	L1	M
PVC	CPVC								
4320-060	4320-060C	6	6	6-1/8	8-1/2	8-5/8	17	17-1/4	7
4320-080	4320-080C	8	7	7-1/8	9-1/2	9-5/8	19	19-1/4	9



Duct - Fume & Air Technical Technical Information

Cross

Belled Socket

(Continued)

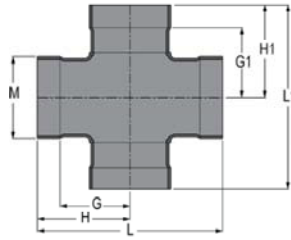

Part Number		Size	G	G1	H	H1	L	L1	M
PVC	CPVC								
4320-100	4320-100C	10	8	8-11/16	10-1/2	11-3/16	21	22-3/8	11-1/8
4320-120	4320-120C	12	9-1/16	9-11/16	11-9/16	12-3/16	23-1/8	24-3/8	13-1/8
4320-140	4320-140C	14	11-3/8	10-13/16	13-7/8	13-5/16	27-3/4	26-5/8	14-3/8
4320-160	4320-160C	16	12-3/8	11-13/16	14-7/8	14-5/16	29-3/4	28-5/8	16-3/8
4320-180	4320-180C	18	13-3/8	12-13/16	15-7/8	15-5/16	31-3/4	30-5/8	18-3/8
4320-200	4320-200C	20	14-3/8	13-3/4	16-7/8	16-1/4	33-3/4	32-1/2	20-7/16
4320-240	4320-240C	24	16-3/4	16-1/2	19-1/4	19	38-1/2	38	24-1/2

Cross, Reducing

Belled Socket

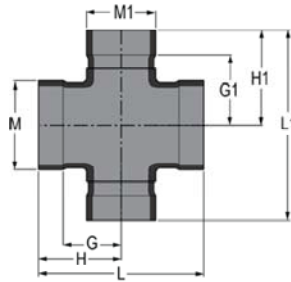

Part Number		Size	G	G1	H	H1	L	L1	M	M1
PVC	CPVC									
4320-532	4320-532C	6X4	5	6-7/16	7-1/2	8-15/16	15	17-7/8	7	5
4320-582	4320-582C	8X4	5	7-7/16	7-1/2	9-15/16	15	19-7/8	9	5
4320-585	4320-585C	8X6	6	7-1/8	8-1/2	9-5/8	17	19-1/4	9	7
4320-624	4320-624C	10X4	5	8-1/2	7-1/2	11	15	22	11-1/8	5
4320-626	4320-626C	10X6	6	8-3/16	8-1/2	10-11/16	17	21-3/8	11-1/8	7
4320-628	4320-628C	10X8	7	8-3/16	9-1/2	10-11/16	19	21-3/8	11-1/8	9
4320-664	4320-664C	12X4	5	9-1/2	7-1/2	12	15	24	13-1/8	5
4320-666	4320-666C	12X6	6	9-3/16	8-1/2	11-11/16	17	23-3/8	13-1/8	7
4320-668	4320-668C	12X8	7	9-3/16	9-1/2	11-11/16	19	23-3/8	13-1/8	9
4320-670	4320-670C	12X10	8	9-11/16	10-1/2	12-3/16	21	24-3/8	13-1/8	11-1/8
4320-694	4320-694C	14X4	6-5/8	11-1/8	9-1/8	13-5/8	18-1/4	27-1/4	14-3/8	5
4320-696	4320-696C	14X6	7-5/8	10-13/16	10-1/8	13-5/16	20-1/4	26-5/8	14-3/8	7
4320-698	4320-698C	14X8	8-5/8	10-13/16	11-1/8	13-5/16	22-1/4	26-5/8	14-3/8	9
4320-700	4320-700C	14X10	9-3/4	10-13/16	12-1/4	13-5/16	24-1/2	26-5/8	14-3/8	11-1/8
4320-702	4320-702C	14X12	10-3/4	10-13/16	13-1/4	13-5/16	26-1/2	26-5/8	14-3/8	13-1/8
4320-754	4320-754C	16X4	6-5/8	12-1/8	9-1/8	14-5/8	18-1/4	28-1/4	16-3/8	5
4320-756	4320-756C	16X6	7-5/8	11-13/16	10-1/8	14-5/16	20-1/4	28-5/8	16-3/8	7
4320-758	4320-758C	16X8	8-5/8	11-13/16	11-1/8	14-5/16	22-1/4	28-5/8	16-3/8	9
4320-760	4320-760C	16X10	9-3/4	11-13/16	12-1/4	14-5/16	24-1/2	28-5/8	16-3/8	11-1/8
4320-762	4320-762C	16X12	10-3/4	11-13/16	13-1/4	14-5/16	26-1/2	28-5/8	16-3/8	13-1/8
4320-764	4320-764C	16X14	11-3/8	11-13/16	13-7/8	14-5/16	27-3/4	28-5/8	16-3/8	14-3/8
4320-784	4320-784C	18X4	6-5/8	13-1/8	9-1/8	15-5/8	18-1/4	31-1/4	18-3/8	5

Cross, Reducing

Belled Socket

(Continued)

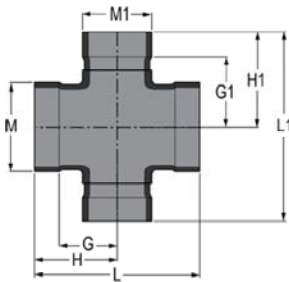

Part Number		Size	G	G1	H	H1	L	L1	M	M1
PVC	CPVC									
4320-786	4320-786C	18X6	7-5/8	12-13/16	10-1/8	15-5/16	20-1/4	30-5/8	18-3/8	7
4320-788	4320-788C	18X8	8-5/8	12-13/16	11-1/8	15-5/16	22-1/4	30-5/8	18-3/8	9
4320-790	4320-790C	18X10	9-3/4	12-13/16	12-1/4	15-5/16	24-1/2	30-5/8	18-3/8	11-1/8
4320-792	4320-792C	18X12	10-3/4	12-13/16	13-1/4	15-5/16	26-1/2	30-5/8	18-3/8	13-1/8
4320-794	4320-794C	18X14	11-3/8	12-13/16	13-7/8	15-5/16	27-3/4	30-5/8	18-3/8	14-3/8
4320-796	4320-796C	18X16	12-3/8	12-13/16	14-7/8	15-5/16	29-3/4	30-5/8	18-3/8	16-3/8
4320-814	4320-814C	20X4	6-5/8	14-1/16	9-1/8	16-9/16	18-1/4	33-1/8	20-7/16	5
4320-816	4320-816C	20X6	7-5/8	13-3/4	10-1/8	16-1/4	20-1/4	32-1/2	20-7/16	7
4320-818	4320-818C	20X8	8-5/8	13-3/4	11-1/8	16-1/4	22-1/4	32-1/2	20-7/16	9
4320-820	4320-820C	20X10	9-3/4	13-3/4	12-1/4	16-1/4	24-1/2	32-1/2	20-7/16	11-1/8
4320-822	4320-822C	20X12	10-3/4	13-3/4	13-1/4	16-1/4	26-1/2	32-1/2	20-7/16	13-1/8
4320-824	4320-824C	20X14	11-3/8	13-3/4	13-7/8	16-1/4	27-3/4	32-1/2	20-7/16	14-3/8
4320-826	4320-826C	20X16	12-3/8	13-3/4	14-7/8	16-1/4	29-3/4	32-1/2	20-7/16	16-3/8
4320-828	4320-828C	20X18	13-3/8	13-3/4	15-7/8	16-1/4	31-3/4	32-1/2	20-7/16	18-3/8
4320-904	4320-904C	24X4	6-5/8	16-1/16	9-1/8	18-9/16	18-1/4	37-1/8	24-1/2	5
4320-906	4320-906C	24X6	7-5/8	15-3/4	10-1/8	18-1/4	20-1/4	36-1/2	24-1/2	7
4320-908	4320-908C	24X8	8-5/8	15-3/4	11-1/8	18-1/4	22-1/4	36-1/2	24-1/2	9
4320-910	4320-910C	24X10	9-3/4	15-3/4	12-1/4	18-1/4	24-1/2	36-1/2	24-1/2	11-1/8
4320-912	4320-912C	24X12	10-3/4	15-3/4	13-1/4	18-1/4	26-1/2	36-1/2	24-1/2	13-1/8
4320-914	4320-914C	24X14	11-3/8	15-3/4	13-7/8	18-1/4	27-3/4	36-1/2	24-1/2	14-3/8
4320-916	4320-916C	24X16	12-3/8	15-3/4	14-7/8	18-1/4	29-3/4	36-1/2	24-1/2	16-3/8
4320-918	4320-918C	24X18	13-3/8	15-3/4	15-7/8	18-1/4	31-3/4	36-1/2	24-1/2	18-3/8
4320-920	4320-920C	24X20	14-3/8	15-3/4	16-7/8	18-1/4	33-3/4	36-1/2	24-1/2	20-7/16

Coupling

Belled Socket

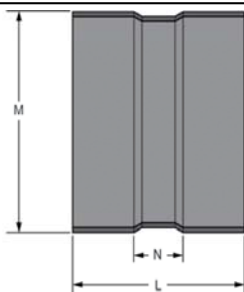

Part Number		Size	L	M	N
PVC	CPVC				
4329-060	4329-060C	6	7	7	2
4329-080	4329-080C	8	7	9	2
4329-100	4329-100C	10	7	11-1/8	2
4329-120	4329-120C	12	7	13-1/8	2
4329-140	4329-140C	14	7	14-3/8	2
4329-160	4329-160C	16	7	16-3/8	2



Duct - Fume & Air Technical Technical Information

Coupling

Belled Socket

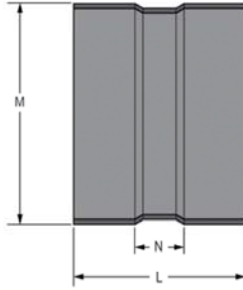

(Continued)

Part Number		Size	L	M	N
PVC	CPVC				
4329-180	4329-180C	18	7	18-3/8	2
4329-200	4329-200C	20	7-1/2	20-7/16	2-1/2
4329-240	4329-240C	24	7-1/2	24-1/2	2-1/2

Coupling, Reducer

Belled Socket

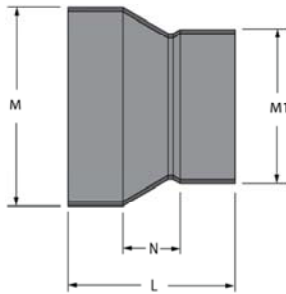

Part Number		Size	L	M	M1	N
PVC	CPVC					
4329-532	4329-532C	6X4	8-3/8	7-1/8	5	3-3/8
4329-582	4329-582C	8X4	13-7/16	9	5	8-7/16
4329-585	4329-585C	8X6	7-5/8	9	7	2-5/8
4329-624	4329-624C	10X4	18-5/8	11-1/8	5	13-5/8
4329-626	4329-626C	10X6	12-13/16	11-1/8	7	7-13/16
4329-628	4329-628C	10X8	7-15/16	11-1/8	9	2-15/16
4329-664	4329-664C	12X4	23-5/8	13-1/8	5	18-5/8
4329-666	4329-666C	12X6	17-7/8	13-1/8	7	12-7/8
4329-668	4329-668C	12X8	13	13-1/8	9	8
4329-670	4329-670C	12X10	7-13/16	13-1/8	11-1/8	2-13/16
4329-694	4329-694C	14X4	28-1/16	14-3/8	5	23-1/16
4329-696	4329-696C	14X6	22-1/4	14-3/8	7	17-1/4
4329-698	4329-698C	14X8	17-3/8	14-3/8	9	12-3/8
4329-700	4329-700C	14X10	12-3/16	14-3/8	11-1/8	7-3/16
4329-702	4329-702C	14X12	7-3/16	14-3/8	13-1/8	2-3/16
4329-754	4329-754C	16X4	33-1/8	16-3/8	5	28-1/8
4329-756	4329-756C	16X6	27-5/16	16-3/8	7	22-5/16
4329-758	4329-758C	16X8	22-7/16	16-3/8	9	17-7/16
4329-760	4329-760C	16X10	17-1/4	16-3/8	11-1/8	12-1/4
4329-762	4329-762C	16X12	12-3/16	16-3/8	13-1/8	7-3/16
4329-764	4329-764C	16X14	7-13/16	16-3/8	14-3/8	2-13/16
4329-784	4329-784C	18X4	38-3/16	18-3/8	5	33-3/16
4329-786	4329-786C	18X6	32-3/8	18-3/8	7	27-3/8
4329-788	4329-788C	18X8	27-1/2	18-3/8	9	22-1/2
4329-790	4329-790C	18X10	22-5/16	18-3/8	11-1/8	17-5/16
4329-792	4329-792C	18X12	17-1/4	18-3/8	13-1/8	12-1/4



Coupling, Reducer

Belled Socket

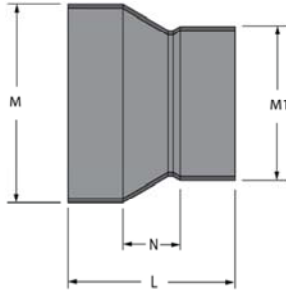

(Continued)

Part Number		Size	L	M	M1	N
PVC	CPVC					
4329-794	4329-794C	18X14	12-7/8	18-3/8	14-3/8	7-7/8
4329-796	4329-796C	18X16	7-13/16	18-3/8	16-3/8	2-13/16
4329-814	4329-814C	20X4	43-1/4	20-3/8	5	38-1/4
4329-816	4329-816C	20X6	37-7/16	20-3/8	7	32-7/16
4329-818	4329-818C	20X8	32-9/16	20-3/8	9	27-9/16
4329-820	4329-820C	20X10	27-3/8	20-3/8	11-1/8	22-3/8
4329-822	4329-822C	20X12	22-5/16	20-3/8	13-1/8	17-5/16
4329-824	4329-824C	20X14	17-15/16	20-3/8	14-3/8	12-15/16
4329-826	4329-826C	20X16	12-7/8	20-3/8	16-3/8	7-7/8
4329-828	4329-828C	20X18	7-7/8	20-3/8	18-3/8	2-7/8
4329-904	4329-904C	24X4	50-1/4	24-1/2	5	45-1/4
4329-906	4329-906C	24X6	44-7/16	24-1/2	7	39-7/16
4329-908	4329-908C	24X8	39-9/16	24-1/2	9	34-9/16
4329-910	4329-910C	24X10	34-3/8	24-1/2	11-1/8	29-3/8
4329-912	4329-912C	24X12	29-5/16	24-1/2	13-1/8	24-5/16
4329-914	4329-914C	24X14	24-15/16	24-1/2	14-3/8	19-15/16
4329-916	4329-916C	24X16	19-7/8	24-1/2	16-3/8	14-7/8
4329-918	4329-918C	24X18	14-7/8	24-1/2	18-3/8	9-7/8
4329-920	4329-920C	24X20	9-3/4	24-1/2	20-7/16	4-3/4

Coupling, Conical Reducer

Belled Socket

SMACNA Compliant Taper for Multi-Step Reducers

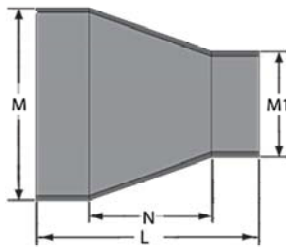

Part Number		Size	L	M	M1	N
PVC	CPVC					
4329C-582	4329C-582C	8X4	10-1/2	9	5-1/16	5-3/4
4329C-624	4329C-624C	10X4	13-3/8	11-1/8	5-1/16	8-5/8
4329C-626	4329C-626C	10X6	10-11/16	11-1/8	7	5-11/16
4329C-664	4329C-664C	12X4	16-3/16	13-1/8	5-1/16	12-3/8
4329C-666	4329C-666C	12X6	13-1/2	13-1/8	7	8-1/2
4329C-668	4329C-668C	12X8	10-5/8	13-1/8	9	5-5/8
4329C-694	4329C-694C	14X4	17-3/4	14-3/8	5-1/16	13-1/8
4329C-696	4329C-696C	14X6	15-1/8	14-3/8	7	10-1/8
4329C-698	4329C-698C	14X8	12-3/8	14-3/8	9	7-3/8
4329C-700	4329C-700C	14X10	9-1/2	14-3/8	11-1/8	4-1/2
4329C-754	4329C-754C	16X4	20-1/2	16-3/8	5-1/16	15-7/8



Coupling, Conical Reducer

(Continued)

Belled Socket
 SMACNA Compliant Taper for Multi-Step
 Reducers

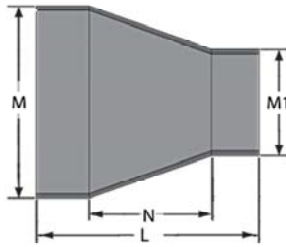

Part Number		Size	L	M	M1	N
PVC	CPVC					
4329C-756	4329C-756C	16X6	18	16-3/8	7	13
4329C-758	4329C-758C	16X8	15-3/16	16-3/8	9	10-3/16
4329C-760	4329C-760C	16X10	12-1/4	16-3/8	11-1/8	7-1/4
4329C-762	4329C-762C	16X12	9-1/2	16-3/8	13-1/8	4-1/2
4329C-784	4329C-784C	18X4	23-1/4	18-3/8	5-1/16	18-5/8
4329C-786	4329C-786C	18X6	20-11/16	18-3/8	7	15-11/16
4329C-788	4329C-788C	18X8	17-15/16	18-3/8	9	12-15/16
4329C-790	4329C-790C	18X10	15	18-3/8	11-1/8	10
4329C-792	4329C-792C	18X12	12-1/4	18-3/8	13-1/8	7-1/4
4329C-794	4329C-794C	18X14	10-1/2	18-3/8	14-3/8	5-1/2
4329C-814	4329C-814C	20X4	25-15/16	20-7/16	5-1/16	21-5/16
4329C-816	4329C-816C	20X6	23-7/16	20-7/16	7	18-7/16
4329C-818	4329C-818C	20X8	20-11/16	20-7/16	9	15-11/16
4329C-820	4329C-820C	20X10	17-3/4	20-7/16	11-1/8	12-3/4
4329C-822	4329C-822C	20X12	15	20-7/16	13-1/8	10
4329C-824	4329C-824C	20X14	13-5/16	20-7/16	14-3/8	8-5/16
4329C-826	4329C-826C	20X16	10-9/16	20-7/16	16-3/8	5-9/16
4329C-904	4329C-904C	24X4	31-7/16	24-1/2	5-1/16	26-13/16
4329C-906	4329C-906C	24X6	28-15/16	24-1/2	7	23-15/16
4329C-908	4329C-908C	24X8	26-3/16	24-1/2	9	21-3/16
4329C-910	4329C-910C	24X10	23-1/4	24-1/2	11-1/8	18-1/4
4329C-912	4329C-912C	24X12	20-1/2	24-1/2	13-1/8	15-1/2
4329C-914	4329C-914C	24X14	18-13/16	24-1/2	14-3/8	13-13/16
4329C-916	4329C-916C	24X16	16-1/16	24-1/2	16-3/8	11-1/16
4329C-918	4329C-918C	24X18	13-5/16	24-1/2	18-3/8	8-5/16
4329C-920	4329C-920C	24X20	10-9/16	24-1/2	20-7/16	5-9/16

Sleeve Coupling

Socket (No Stop)

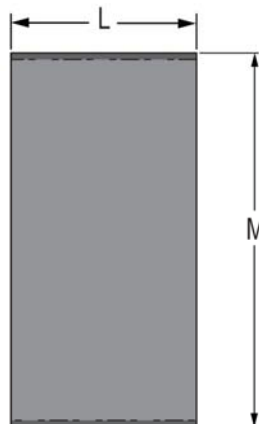

Part Number		Size	L	M
PVC	CPVC			
4329S-060	4329S-060C	6	6	7
4329S-080	4329S-080C	8	6	9

Sleeve Coupling

Socket (No Stop)

(Continued)



Part Number		Size	L	M
PVC	CPVC			
4329S-100	4329S-100C	10	6	11-1/8
4329S-120	4329S-120C	12	6	13-1/8
4329S-140	4329S-140C	14	6	14-3/8
4329S-160	4329S-160C	16	6	16-3/8
4329S-180	4329S-180C	18	6	18-3/8
4329S-200	4329S-200C	20	6	20-7/16
4329S-240	4329S-240C	24	6	24-1/2

Flat Cap

Belled Socket

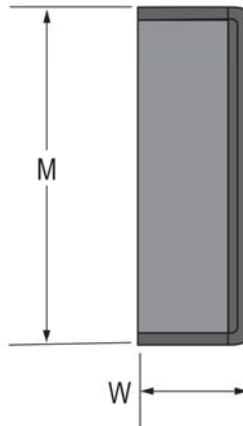

Part Number		Size	M	W
PVC	CPVC			
4347-060	4347-060C	6	7	3-1/4
4347-080	4347-080C	8	9	3-1/4
4347-100	4347-100C	10	11-1/4	3-3/16
4347-120	4347-120C	12	13-1/4	3-1/4
4347-140	4347-140C	14	14-3/8	3-1/4
4347-160	4347-160C	16	16-3/8	2-15/16
4347-180	4347-180C	18	18-3/8	3-1/4
4347-200	4347-200C	20	20-7/16	3
4347-240	4347-240C	24	24-1/2	3-1/4



Duct - Fume & Air Technical
Technical Information

Rain Cap

Belled Socket Style A

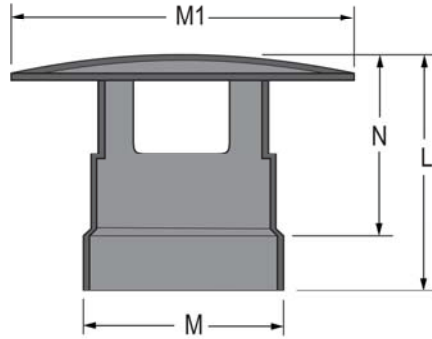

Part Number		Size	L	M	M1	N
PVC	CPVC					
4347-060A	4347-060AC	6	8-13/16	7	12	6- 5/16
4347-080A	4347-080AC	8	11-3/8	9	16	8- 7/8
4347-100A	4347-100AC	10	12-3/8	11-1/8	20	9- 7/8
4347-120A	4347-120AC	12	15	13-1/8	24	12- 1/2
4347-140A	4347-140AC	14	17-13/16	14-3/8	28	15- 5/16
4347-160A	4347-160AC	16	18-11/16	16-3/8	32	16-3/16
4347-180A	4347-180AC	18	20- 7/8	18-3/8	36	18-3/8
4347-200A	4347-200AC	20	21-7/8	20-7/16	40	19-3/8
4347-240A	4347-240AC	24	25-1/16	24-1/2	48	22-9/16

Rain Cap

Belled Socket Style B

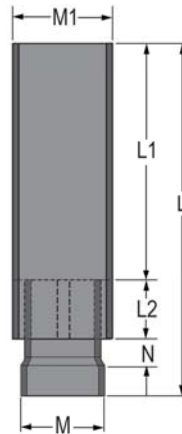

Part Number		Size	L	L1	L2	M	M1	N
PVC	CPVC							
4347-060B	4347-060BC	6	34-1/2	24	6	7	8-5/8	2
4347-080B	4347-080BC	8	42-1/2	32	6	9	10-3/4	2
4347-100B	4347-100BC	10	50-1/2	40	6	11-1/8	12-3/4	2
4347-120B	4347-120BC	12	58-1/2	48	6	13-1/8	14	2
4347-140B	4347-140BC	14	66-1/2	56	6	14-3/8	16	2
4347-160B	4347-160BC	16	74-1/2	64	6	16-3/8	18	2
4347-180B	4347-180BC	18	82-1/2	72	6	18-3/8	20	2
4347-200B	4347-200BC	20	90-1/2	80	6	20-7/16	24	2
4347-240B	4347-240BC	24	109-1/2	96	9	24-1/2	26	2



PVC Flange- SMACNA

Bellied Socket One Piece
 SMACNA Bolt Pattern

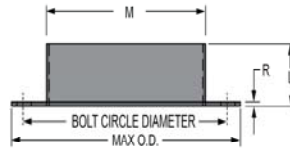

Part Number	Size	L	M	R	Bolt Circle Dia.	Hole Size	Max. O.D.	No of Bolts
4351S-060	6	3-1/2	7	3/16	8-1/2	5/16	10	8
4351S-080	8	3-1/2	9	3/16	10-1/2	5/16	12	10
4351S-100	10	3-1/2	11-1/8	3/16	12-1/2	5/16	14	12
4351S-120	12	3-1/2	13-1/8	3/16	14-3/8	5/16	16	16
4351S-140	14	3-1/2	14-3/8	3/16	16-1/2	5/16	18	16
4351S-160	16	2-3/4	16-3/8	1/4	18-1/2	5/16	20	18
4351S-180	18	2-3/4	18-3/8	1/4	20-1/2	5/16	22	20
4351S-200	20	2-3/4	20-7/16	1/4	22-1/2	5/16	24	22
4351S-240	24	2-3/4	24-1/2	1/4	26-1/2	5/16	28	24

CPVC Flange- SMACNA

Bellied Socket One Piece
 SMACNA Bolt Pattern

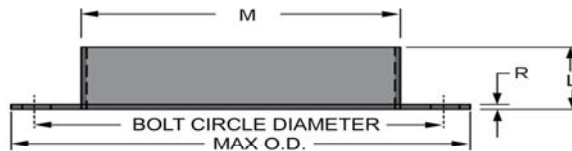

Part Number	Size	L	M	R	Bolt Circle Dia.	Hole Size	Max. O.D.	No of Bolts
4351S-060C	6	2-11/16	7	3/16	8-1/2	5/16	10	8
4351S-080C	8	2-11/16	9	3/16	10-1/2	5/16	12	10
4351S-100C	10	2-11/16	11-1/8	3/16	12-1/2	5/16	14	12
4351S-120C	12	2-3/4	13-1/8	1/4	14-3/8	5/16	16	16
4351S-140C	14	2-3/4	14-3/8	1/4	16-1/2	5/16	18	16
4351S-160C	16	2-3/4	16-3/8	1/4	18-1/2	5/16	20	18
4351S-180C	18	2-3/4	18-3/8	1/4	20-1/2	5/16	22	20
4351S-200C	20	2-3/4	20-7/16	1/4	22-1/2	5/16	24	22
4351S-240C	24	2-3/4	24-1/2	1/4	26-1/2	5/16	28	24



Flange, Blind

One Piece
 Class 150 Bolt Pattern



Part Number		Size	R	Bolt Circle Dia.	Hole Size	Max. O.D.	No of Bolts
PVC	CPVC						
4353-060	4353-060C	6	1/4	9-1/2	7/8	11	8
4353-080	4353-080C	8	1/4	11-3/4	7/8	13-1/2	8
4353-100	4353-100C	10	1/4	14-1/4	1	16	12
4353-120	4353-120C	12	1/4	17	1	19	12
4353-140	4353-140C	14	1/4	18-3/4	1-1/8	21	12
4353-160	4353-160C	16	1/4	21-1/4	1-1/8	23-1/2	16
4353-180	4353-180C	18	1/4	22-3/4	1-1/4	25	16
4353-200	4353-200C	20	1/4	25	1-1/4	27-1/2	20
4353-240	4353-240C	24	1/4	29-1/2	1-3/8	32	20

Flange, Blind - SMACNA

One Piece
 SMACNA Bolt Pattern



Part Number		Size	R	Bolt Circle Dia.	Hole Size	Max. O.D.	No of Bolts
PVC	CPVC						
4353S-060	4353S-060C	6	1/4	8-1/2	5/16	10	8
4353S-080	4353S-080C	8	1/4	10-1/2	5/16	12	10
4353S-100	4353S-100C	10	1/4	12-1/2	5/16	14	12
4353S-120	4353S-120C	12	1/4	14-3/8	5/16	16	16
4353S-140	4353S-140C	14	1/4	16-1/2	5/16	18	16
4353S-160	4353S-160C	16	1/4	18-1/2	5/16	20	18
4353S-180	4353S-180C	18	1/4	20-1/2	5/16	22	20
4353S-200	4353S-200C	20	1/4	22-1/2	5/16	24	22
4353S-240	4353S-240C	24	1/4	26-1/2	5/16	28	24

Duct - Fume & Air Technical
Technical Information



Wye
 Belled Socket

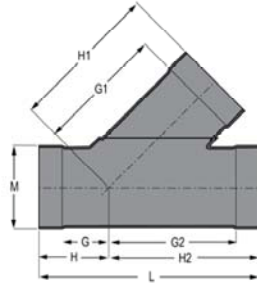

Part Number		Size	G	G1	G2	H	H1	H2	L	M
PVC	CPVC									
4375-060	4375-060C	6	4-3/16	11-1/4	10-13/16	6-11/16	13-3/4	13-5/16	20	7
4375-080	4375-080C	8	5-1/16	13-5/8	13-11/16	7-9/16	16-1/8	16-3/16	23-3/4	9
4375-100	4375-100C	10	6-1/4	16-3/16	17	8-3/4	18-11/16	19-1/2	28-1/4	11-1/8
4375-120	4375-120C	12	5-13/16	18-5/8	18-9/16	8-3/8	21-1/8	21-1/8	29-1/2	13-1/8
4375-140	4375-140C	14	7-7/8	20-5/8	21-7/8	10-3/8	23-1/8	24-3/8	34-3/4	14-3/8
4375-160	4375-160C	16	7-1/8	23-1/16	23-1/8	9-5/8	25-9/16	25-5/8	35-1/4	16-3/8
4375-180	4375-180C	18	7-1/2	25-7/16	25-1/2	10	27-15/16	28	38	18-3/8
4375-200	4375-200C	20	10-3/4	28-1/16	30-3/4	13-1/4	30-9/16	33-1/4	46-1/2	20-7/16
4375-240	4375-240C	24	9-11/16	33-11/16	33-11/16	12-3/16	36-3/16	36-3/16	48-3/8	24-1/2

Wye, Reducing
 Belled Socket

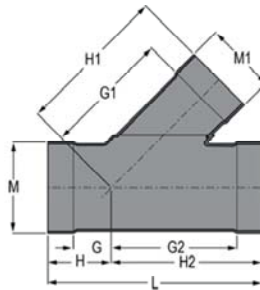

Part Number		Size	G	G1	G2	H	H1	H2	L	M	M1
PVC	CPVC										
4375-532	4375-532C	6X4	2-7/16	9-11/16	9-1/16	4-15/16	12-3/16	11-9/16	16-1/2	7	5
4375-582	4375-582C	8X4	1-7/16	11-1/16	10-1/16	3-15/16	13-9/16	12-9/16	16-1/2	9	5
4375-585	4375-585C	8X6	3-11/16	12-5/8	12-5/16	6-3/16	15-1/8	14-13/16	21	9	7
4375-624	4375-624C	10X4	3/8	12-9/16	11-1/8	2-7/8	15-1/16	13-5/8	16-1/2	11-1/8	5
4375-626	4375-626C	10X6	2-5/8	14-1/8	13-3/8	5-1/8	16-5/8	15-7/8	21	11-1/8	7
4375-628	4375-628C	10X8	4	15-1/8	14-3/4	6-1/2	17-5/8	17-1/4	23-3/4	11-1/8	9
4375-664	4375-664C	12X4	5/8	14	12-1/8	1-7/8	16-1/2	14-5/8	16-1/2	13-1/8	5
4375-666	4375-666C	12X6	1-5/8	15-9/16	14-3/8	4-1/8	18-1/16	16-7/8	21	13-1/8	7
4375-668	4375-668C	12X8	3	16-9/16	15-3/4	5-1/2	19-1/16	18-1/4	23-3/4	13-1/8	9
4375-670	4375-670C	12X10	4-1/2	17-5/8	17-1/4	7	20-1/8	19-3/4	26-3/4	13-1/8	11-1/8
4375-694	4375-694C	14X4	1-1/4	14-7/8	12-3/4	1-1/4	17-3/8	15-1/4	16-1/2	14-3/8	5
4375-696	4375-696C	14X6	1	16-7/16	15	3-1/2	18-15/16	17-1/2	21	14-3/8	7
4375-698	4375-698C	14X8	2-3/8	17-7/16	16-3/8	4-7/8	19-15/16	18-7/8	23-3/4	14-3/8	9
4375-700	4375-700C	14X10	3-7/8	18-1/2	17-7/8	6-3/8	21	20-3/8	26-3/4	14-3/8	11-1/8
4375-702	4375-702C	14X12	5-1/4	19-1/2	19-1/4	7-3/4	22	21-3/4	29-1/2	14-3/8	13-1/8
4375-754	4375-754C	16X4	2-1/4	16-1/2	13-3/4	1/4	18-13/16	16-1/4	16-1/2	16-3/8	5
4375-756	4375-756C	16X6	0	17-7/8	16	2-1/2	20-3/8	18-1/2	21	16-3/8	7
4375-758	4375-758C	16X8	1-3/8	18-7/8	17-3/8	3-7/8	21-3/8	19-7/8	23-3/4	16-3/8	9
4375-760	4375-760C	16X10	2-7/8	19-15/16	18-7/8	5-3/8	22-7/16	21-3/8	26-3/4	16-3/8	11-1/8
4375-762	4375-762C	16X12	4-1/4	20-5/16	20-1/4	6-3/4	23-7/16	22-3/4	29-1/2	16-3/8	13-1/8



Wye, Reducing

Belled Socket

(Continued)

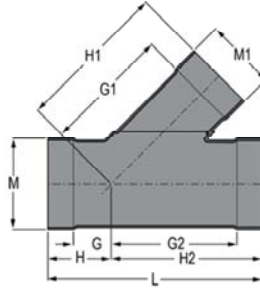

Part Number		Size	G	G1	G2	H	H1	H2	L	M	M1
PVC	CPVC										
4375-764	4375-764C	16X14	6-1/8	22-1/16	22-1/8	8-5/8	24-9/16	24-5/8	33-1/4	16-3/8	14-3/8
4375-784	4375-784C	18X4	3/4	17-11/16	14-3/4	3-1/4	20-3/16	17-1/4	16-1/2	18-3/8	5
4375-786	4375-786C	18X6	1	19-1/4	17	1-1/2	21-3/4	19-1/2	21	18-3/8	7
4375-788	4375-788C	18X8	3/8	20-1/4	18-3/8	2-7/8	22-3/4	20-7/8	23-3/4	18-3/8	9
4375-790	4375-790C	18X10	1-7/8	21-5/16	19-7/8	4-3/8	23-13/16	22-3/8	26-3/4	18-3/8	11-1/8
4375-792	4375-792C	18X12	3-1/4	22-5/16	21-1/4	5-3/4	24-13/16	23-3/4	29-1/2	18-3/8	13-1/8
4375-794	4375-794C	18X14	5-1/8	23-7/16	23-1/8	7-5/8	25-15/16	25-5/8	33-1/4	18-3/8	14-3/8
4375-796	4375-796C	18X16	6-1/8	24-7/16	24-1/8	8-5/8	26-15/16	26-5/8	35-1/4	18-3/8	16-3/8
4375-814	4375-814C	20X4	4-1/4	19-1/16	15-3/4	1-3/4	21-9/16	18-1/4	16-1/2	20-7/16	5
4375-816	4375-816C	20X6	2	20-5/8	18	1/2	23-1/8	20-1/2	21	20-7/16	7
4375-818	4375-818C	20X8	5/8	21-5/8	19-3/8	1-7/8	24-1/8	21-7/8	23-3/4	20-7/16	9
4375-820	4375-820C	20X10	7/8	22-11/16	20-7/8	3-3/8	25-3/16	23-3/8	26-3/4	20-7/16	11-1/8
4375-822	4375-822C	20X12	2-1/4	23-11/16	22-1/4	4-3/4	26-3/16	24-3/4	29-1/2	20-7/16	13-1/8
4375-824	4375-824C	20X14	4-1/8	24-13/16	24-1/8	6-5/8	27-5/16	26-5/8	33-1/4	20-7/16	14-3/8
4375-826	4375-826C	20X16	5-1/8	25-13/16	25-1/8	7-5/8	28-5/16	27-5/8	35-1/4	20-7/16	16-3/8
4375-828	4375-828C	20X18	6-1/2	26-13/16	26-1/2	9	29-5/16	29	38	20-7/16	18-3/8
4375-904	4375-904C	24X4	6-1/4	21-7/8	17-3/4	3-3/4	24-3/8	20-1/4	16-1/2	24-1/2	5
4375-906	4375-906C	24X6	4	23-7/16	20	1-1/2	25-15/16	22-1/2	21	24-1/2	7
4375-908	4375-908C	24X8	2-5/8	24-7/16	21-3/8	1/8	26-15/16	23-7/8	23-3/4	24-1/2	9
4375-910	4375-910C	24X10	1-1/8	25-1/2	22-7/8	1-3/8	28	25-3/8	26-3/4	24-1/2	11-1/8
4375-912	4375-912C	24X12	1/4	26-1/2	24-1/4	2-3/4	29	26-3/4	29-1/2	24-1/2	13-1/8
4375-914	4375-914C	24X14	2-1/8	27-5/8	26-1/8	4-5/8	30-1/8	28-5/8	33-1/4	24-1/2	14-3/8
4375-916	4375-916C	24X16	3-1/8	28-5/8	27-1/8	5-5/8	31-1/8	29-5/8	35-1/4	24-1/2	16-3/8
4375-918	4375-918C	24X18	4-1/2	29-5/8	28-1/2	7	32-1/8	31	38	24-1/2	18-3/8
4375-920	4375-920C	24X20	8-3/4	30-7/8	32-3/4	11-1/4	33-3/8	35-1/4	46-1/2	24-1/2	20-7/16

Wye, Double

Belled Socket

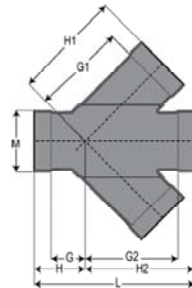

Part Number		Size	G	G1	G2	H	H1	H2	L	M
PVC	CPVC									
4376-060	4376-060C	6	4-3/16	11-1/4	10-13/16	6-11/16	13-3/4	13-5/16	20	7
4376-080	4376-080C	8	5-1/16	13-5/8	13-11/16	7-9/16	16-1/8	16-3/16	23-3/4	9
4376-100	4376-100C	10	6-1/4	16-3/16	17	8-3/4	18-11/16	19-1/2	28-1/4	11-1/8
4376-120	4376-120C	12	5-13/16	18-5/8	18-9/16	8-3/8	21-1/8	21-1/8	29-1/2	13-1/8

Duct - Fume & Air Technical
Technical Information



Wye, Double

Belled Socket

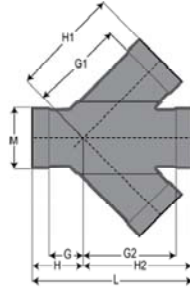

(Continued)

Part Number		Size	G	G1	G2	H	H1	H2	L	M
PVC	CPVC									
4376-140	4376-140C	14	7-7/8	20-5/8	21-7/8	10-3/8	23-1/8	24-3/8	34-3/4	14-3/8
4376-160	4376-160C	16	7-1/8	23-1/16	23-1/8	9-5/8	25-9/16	25-5/8	35-1/4	16-3/8
4376-180	4376-180C	18	7-1/2	25-7/16	25-1/2	10	27-15/16	28	38	18-3/8
4376-200	4376-200C	20	10-3/4	28-1/16	30-3/4	13-1/4	30-9/16	33-1/4	46-1/2	20-7/16
4376-240	4376-240C	24	9-11/16	33-11/16	33-11/16	12-3/16	36-3/16	36-3/16	48-3/8	24-1/2

Wye, Double Reducing

Belled Socket

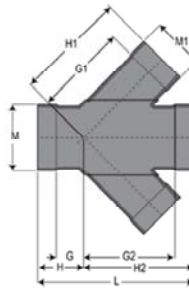

Part Number		Size	G	G1	G2	H	H1	H2	L	M	M1
PVC	CPVC										
4376-532	4376-532C	6X4	2-7/16	9-11/16	9-1/16	4-15/16	12-3/16	11-9/16	16-1/2	7	5
4376-582	4376-582C	8X4	1-7/16	11-1/16	10-1/16	3-15/16	13-9/16	12-9/16	16-1/2	9	5
4376-585	4376-585C	8X6	3-11/16	12-5/8	12-5/16	6-3/16	15-1/8	14-13/16	21	9	7
4376-624	4376-624C	10X4	3/8	12-9/16	11-1/8	2-7/8	15-1/16	13-5/8	16-1/2	11-1/8	5
4376-626	4376-626C	10X6	2-5/8	14-1/8	13-3/8	5-1/8	16-5/8	15-7/8	21	11-1/8	7
4376-628	4376-628C	10X8	4	15-1/8	14-3/4	6-1/2	17-5/8	17-1/4	23-3/4	11-1/8	9
4376-664	4376-664C	12X4	5/8	14	12-1/8	1-7/8	16-1/2	14-5/8	16-1/2	13-1/8	5
4376-666	4376-666C	12X6	1-5/8	15-9/16	14-3/8	4-1/8	18-1/16	16-7/8	21	13-1/8	7
4376-668	4376-668C	12X8	3	16-9/16	15-3/4	5-1/2	19-1/16	18-1/4	23-3/4	13-1/8	9
4376-670	4376-670C	12X10	4-1/2	17-5/8	17-1/4	7	20-1/8	19-3/4	26-3/4	13-1/8	11-1/8
4376-694	4376-694C	14X4	1-1/4	14-7/8	12-3/4	1-1/4	17-3/8	15-1/4	16-1/2	14-3/8	5
4376-696	4376-696C	14X6	1	16-7/16	15	3-1/2	18-15/16	17-1/2	21	14-3/8	7
4376-698	4376-698C	14X8	2-3/8	17-7/16	16-3/8	4-7/8	19-15/16	18-7/8	23-3/4	14-3/8	9
4376-700	4376-700C	14X10	3-7/8	18-1/2	17-7/8	6-3/8	21	20-3/8	26-3/4	14-3/8	11-1/8
4376-702	4376-702C	14X12	5-1/4	19-1/2	19-1/4	7-3/4	22	21-3/4	29-1/2	14-3/8	13-1/8
4376-754	4376-754C	16X4	2-1/4	16-5/16	13-3/4	1/4	18-13/16	16-1/4	16-1/2	16-3/8	5
4376-756	4376-756C	16X6	0	17-7/8	16	2-1/2	20-3/8	18-1/2	21	16-3/8	7
4376-758	4376-758C	16X8	1-3/8	18-7/8	17-3/8	3-7/8	21-3/8	19-7/8	23-3/4	16-3/8	9
4376-760	4376-760C	16X10	2-7/8	19-15/16	18-7/8	5-3/8	22-7/16	21-3/8	26-3/4	16-3/8	11-1/8
4376-762	4376-762C	16X12	4-1/4	20-15/16	20-1/4	6-3/4	23-7/16	22-3/4	29-1/2	16-3/8	13-1/8
4376-764	4376-764C	16X14	6-1/8	22-1/16	22-1/8	8-5/8	24-9/16	24-5/8	33-1/4	16-3/8	14-3/8
4376-784	4376-784C	18X4	3/4	17-11/16	14-3/4	3-1/4	20-3/16	17-1/4	16-1/2	18-3/8	5
4376-786	4376-786C	18X6	1	19-1/4	17	1-1/2	21-3/4	19-1/2	21	18-3/8	7
4376-788	4376-788C	18X8	3/8	20-1/4	18-3/8	2-7/8	22-3/4	20-7/8	23-3/4	18-3/8	9



Wye, Double Reducing

Belled Socket

(Continued)

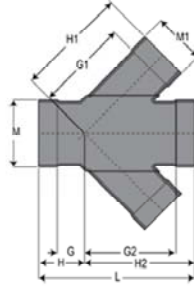

Part Number		Size	G	G1	G2	H	H1	H2	L	M	M1
PVC	CPVC										
4376-790	4376-790C	18X10	1-7/8	21-5/16	19-7/8	4-3/8	23-13/16	22-3/8	26-3/4	18-3/8	11-1/8
4376-792	4376-792C	18X12	3-1/4	22-5/16	21-1/4	5-3/4	24-13/16	23-3/4	29-1/2	18-3/8	13-1/8
4376-794	4376-794C	18X14	5-1/8	23-7/16	23-1/8	7-5/8	25-15/16	25-5/8	33-1/4	18-3/8	14-3/8
4376-796	4376-796C	18X16	6-1/8	24-7/16	24-1/8	8-5/8	26-15/16	26-5/8	35-1/4	18-3/8	16-3/8
4376-814	4376-814C	20X4	4-1/4	19-1/16	15-3/4	1-3/4	21-9/16	18-1/4	16-1/2	20-7/16	5
4376-816	4376-816C	20X6	2	20-5/8	18	1/2	23-1/8	20-1/2	21	20-7/16	7
4376-818	4376-818C	20X8	5/8	21-5/8	19-3/8	1-7/8	24-1/8	21-7/8	23-3/4	20-7/16	9
4376-820	4376-820C	20X10	7/8	22-11/16	20-7/8	3-3/8	25-3/16	23-3/8	26-3/4	20-7/16	11-1/8
4376-822	4376-822C	20X12	2-1/4	23-11/16	22-1/4	4-3/4	26-3/16	24-3/4	29-1/2	20-7/16	13-1/8
4376-824	4376-824C	20X14	4-1/8	24-13/16	24-1/8	6-5/8	27-5/16	26-5/8	33-1/4	20-7/16	14-3/8
4376-826	4376-826C	20X16	5-1/8	25-13/16	25-1/8	7-5/8	28-5/16	27-5/8	35-1/4	20-7/16	16-3/8
4376-828	4376-828C	20X18	6-1/2	26-13/16	26-1/2	9	29-5/16	29	38	20-7/16	18-3/8
4376-904	4376-904C	24X4	6-1/4	21-7/8	17-3/4	3-3/4	24-3/8	20-1/4	16-1/2	24-1/2	5
4376-906	4376-906C	24X6	4	23-7/16	20	1-1/2	25-15/16	22-1/2	21	24-1/2	7
4376-908	4376-908C	24X8	2-5/8	24-7/16	21-3/8	1/8	26-15/16	23-7/8	23-3/4	24-1/2	9
4376-910	4376-910C	24X10	1-1/8	25-1/2	22-7/8	1-3/8	28	25-3/8	26-3/4	24-1/2	11-1/8
4376-912	4376-912C	24X12	1/4	26-1/2	24-1/4	2-3/4	29	26-3/4	29-1/2	24-1/2	13-1/8
4376-914	4376-914C	24X14	2-1/8	27-5/8	26-1/8	4-5/8	30-1/8	28-5/8	33-1/4	24-1/2	14-3/8
4376-916	4376-916C	24X16	3-1/8	28-5/8	27-1/8	5-5/8	31-1/8	29-5/8	35-1/4	24-1/2	16-3/8
4376-918	4376-918C	24X18	4-1/2	29-5/8	28-1/2	7	32-1/8	31	38	24-1/2	18-3/8
4376-920	4376-920C	24X20	8-3/4	30-7/8	32-3/4	11-1/4	33-3/8	35-1/4	46-1/2	24-1/2	20-7/16

Blast Gate

Belled End

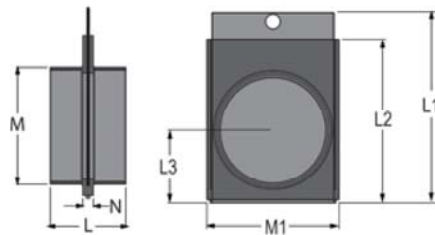

Part Number		Size	L	L1	L2	L3	M	M1	N
PVC	CPVC								
43BG-060	43BG-060C	6	5-3/4	12-3/8	10-1/4	4-1/2	7	8-3/4	15/16
43BG-080	43BG-080C	8	5-13/16	14-11/16	12-5/8	5-5/8	9	10-3/16	13/16
43BG-100	43BG-100C	10	5-5/8	16-1/4	14-5/8	6-5/8	11-1/8	13	5/8
43BG-120	43BG-120C	12	5-5/8	19-1/4	17-1/2	7-7/8	13-1/8	13-5/8	5/8

Blast Gate

(Continued)

Belled End

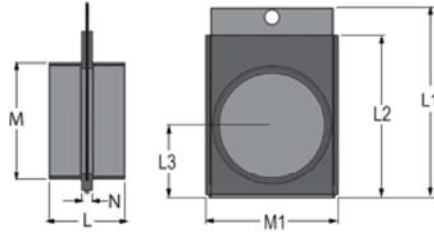

Part Number		Size	L	L1	L2	L3	M	M1	N
PVC	CPVC								
43BG-140	43BG-140C	14	5-5/8	22-3/16	20-3/4	8-1/2	14-3/8	16-3/4	5/8
43BG-160	43BG-160C	16	5-5/8	22-1/4	20-3/4	9-1/2	16-3/8	16-3/4	5/8
43BG-180	43BG-180C	18	5-5/8	25-1/4	23-3/4	10-1/2	18-3/8	22-1/8	5/8
43BG-200	43BG-200C	20	5-5/8	29	26-1/4	11-1/2	20-7/16	25-1/8	5/8
43BG-240	43BG-240C	24	5-5/8	33	30-1/4	13-1/2	24-1/2	25-1/8	5/8

Butterfly Damper

Belled Socket

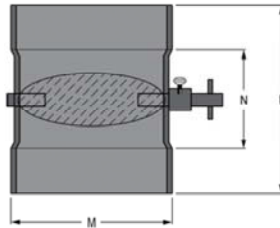

Part Number		Size	L	M	N
PVC	CPVC				
43BD-060	43BD-060C	6	8-1/4	7	3-1/4
43BD-080	43BD-080C	8	10-1/2	9	5-1/2
43BD-100	43BD-100C	10	13	11-1/8	8
43BD-120	43BD-120C	12	14-1/2	13-1/8	9-1/2
43BD-140	43BD-140C	14	14-1/2	14-3/8	9-1/2
43BD-160	43BD-160C	16	17	16-3/8	12
43BD-180	43BD-180C	18	20	18-3/8	15
43BD-200	43BD-200C	20	22	20-7/16	17
43BD-240	43BD-240C	24	26	24-1/2	21



Duct Hangers

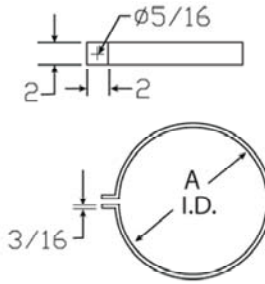

Part Number		Size	A
PVC	CPVC		
43DH-060	43DH-060C	6	6-5/8
43DH-080	43DH-080C	8	8-5/8
43DH-100	43DH-100C	10	10-3/4
43DH-120	43DH-120C	12	12-3/4
43DH-140	43DH-140C	14	14
43DH-160	43DH-160C	16	16
43DH-180	43DH-180C	18	18
43DH-200	43DH-200C	20	20
43DH-240	43DH-240C	24	24

