



Expansion Joints



ENGINEERING GUIDE

Contact Spears® for any information not found.



**Triple O-ring Sealed Telescoping Design
 Available With 6" and 12" Travel**



Linear expansion and contraction from temperature fluctuations can be a major problem in thermoplastic piping systems. Forces left uncontrolled can literally tear systems apart. Spears® Expansion Joint allows a telescoping movement of an inner pipe within a firmly mounted outer tube to eliminate such damage. Available for CPVC 1/2" through 12" and PVC 1/2" through 14" IPS piping systems in 6" or 12" maximum travel lengths. Custom produced for virtually any pipe diameter.

**Compact Installation -
 Eliminates Need For Expansion Loops**

Telescoping design allows more compact installation than possible with conventional expansion loops and permits rigid mounting between two fixed points.

**EPDM or FKM Pressure O-ring Seal with
 Dual "Wiper" O-ring for Extended Life**

Designed for sealing dependability, O-ring pressure seal utilizes two (2) additional "wiper" O-rings to remove dirt and particles that would normally wear joint seals during operation. Long-life Expansion Joint requires no repair or replacement. Standard O-ring for PVC is EPDM, for CPVC is FKM.

**Support Piston Eliminates Binding,
 Minimizes Alignment Problems**

Alignment is critical in use of expansion joints. Specially designed support piston eliminates binding and minimizes alignment problems which can result in cocking or breakage.

Excellent For Use as a Repair Coupling

Simply cut damaged pipe section from line, collapse expansion joint, solvent cement ends and expand halfway to install.

Sample Engineering Specifications

All Expansion Joints shall be telescoping design with triple (3) EPDM or FKM O-ring seals, including center pressure seal and outer debris seals, and internal support piston. Maximum joint travel length shall be either 6" or 12". All Expansion Joints shall be pressure rated according to the manufacturer's specifications [see table] for water at 73°F. All Expansion Joints shall be fabricated from PVC or CPVC material conforming to ASTM D 1784. All sockets shall meet the dimensional requirements of ASTM D 2467, as manufactured by Spears® Manufacturing Company.

Linear Expansion and Contraction

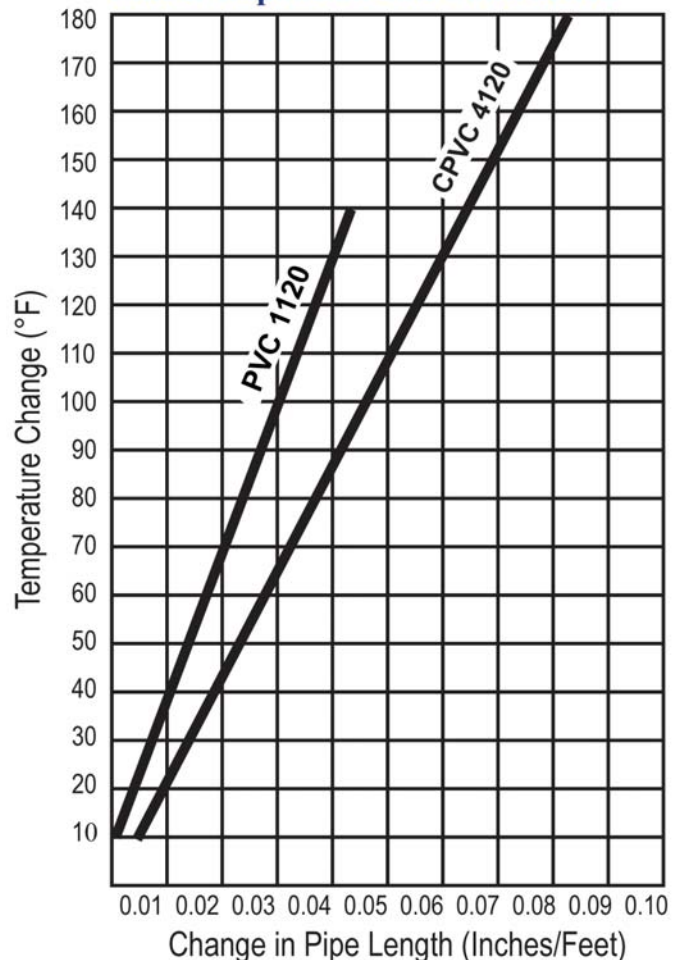

Coefficient of Thermal Linear Expansion

PVC 1120	=	2.8×10^{-5} in/in/°F
CPVC 4120	=	3.4×10^{-5} in/in/°F



Expansion Joints Technical

Expansion Joint Overview

DETERMINING TRAVEL LENGTH NEEDED

General Rule: For PVC systems, allow 3/8" expansion for every 10°F change in temperature per 100 feet of pipe, (all diameters). For CPVC systems, allow 1/2" expansion for every 10°F change in temperature per 100 feet of pipe, (all diameters). For example, a 6" travel expansion joint will accommodate approximately 160°F temperature change in 100 ft. of PVC pipe ($16 \times 3/8" = 6"$) or approximately 120°F temperature change in 100 ft. of CPVC pipe ($12 \times 1/2" = 6"$).

INSTALLATION

Expansion Joints consist of two telescoping tubes with internal O-ring seals. For proper operation, the outer tube should be firmly anchored to allow free movement of the inner tube or "piston". Support and thrust block the system to direct movement squarely into the Expansion Joint. Alignment is critical, axial guides should be installed to ensure straight movement into expansion joint. Provisions should be made to protect the cylinder shaft from scratches, damage and debris to prevent leaks. Expansion Joints can be installed at the travel range midpoint for most general installations and are shipped from the factory in this position. If desired, the extended position for installation may be additionally adjusted to specific system and installation parameters using the following calculation:



6" EXPANSION JOINT DIMENSION							
Size	M	M1	L-CLOSED	L-OPEN	N-CLOSED	N-OPEN	Pressure Rating @ 73°F
1/2"	1-3/16	1-3/4	10-9/16	16-9/16	8-13/16	14-13/16	235
3/4"	1-7/16	2-1/8	12	18	10	16	235
1"	1-5/8	2-3/8	12-1/2	18-1/2	10-1/4	16-1/4	235
1-1/4"	2-1/4	2-3/8	13-1/16	19-1/16	10-1/2	16-1/2	235
1-1/2"	2-3/8	2-7/8	13-1/4	19-1/4	10-7/16	16-7/16	235
2"	2-7/8	3-1/2	14-7/16	20-7/16	11-7/16	17-7/16	235
2-1/2"	4-3/16	4-1/2	16-1/4	22-1/4	12-3/4	18-3/4	150
3"	4-3/16	4-1/2	15-5/8	21-5/8	11-13/16	17-13/16	150
4"	5-1/4	5-9/16	16-15/16	22-15/16	12-9/16	18-9/16	150
6"	7-9/16	8-5/8	19-3/4	25-3/4	13-5/8	19-5/8	150
8"	9-11/16	10-3/4	24-1/2	30-1/2	16-9/16	22-9/16	150

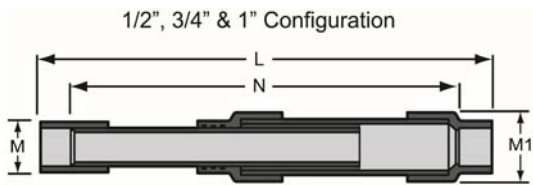

10"	12-1/16	12-3/4	28-7/8	34-7/8	18-7/8	24-7/8	150
12"	14-1/4	16	34	40	22	28	150
14"	15-1/2	16	40-3/4	46-3/4	26	32	100

12" EXPANSION JOINT DIMENSIONS							
Size	M	M1	L-CLOSED	L-OPEN	N-CLOSED	N-OPEN	Pressure Rating @ 73°F
1/2"	1-3/16	1-3/4	16-9/16	28-9/16	14-13/16	26-13/16	235
3/4"	1-7/16	2-1/8	18	30	16	28	235
1"	1-5/8	2-3/8	18-1/2	30-1/2	16-1/4	28-1/4	235
1-1/4"	2-1/4	2-3/8	19-1/16	31-1/16	16-1/2	28-1/2	235
1-1/2"	2-3/8	2-7/8	19-1/4	31-1/4	16-7/16	28-7/16	235
2"	2-7/8	3-1/2	20-7/16	32-7/16	17-7/16	29-7/16	235
2-1/2"	4-3/16	4-1/2	22-1/4	34-1/4	18-3/4	30-3/4	150
3"	4-3/16	4-1/2	21-5/8	33-5/8	17-13/16	29-13/16	150
4"	5-1/4	5-9/16	22-15/16	34-15/16	18-9/16	30-9/16	150
6"	7-9/16	8-5/8	25-3/4	37-3/4	19-5/8	31-5/8	150
8"	9-11/16	10-3/4	30-1/2	42-1/2	22-9/16	34-9/16	150
10"	12-1/16	12-3/4	34-7/8	46-7/8	24-7/8	36-7/8	150
12"	14-1/4	16	40	52	28	40	150
14"	15-1/2	16	46-3/4	58-3/4	32	44	100

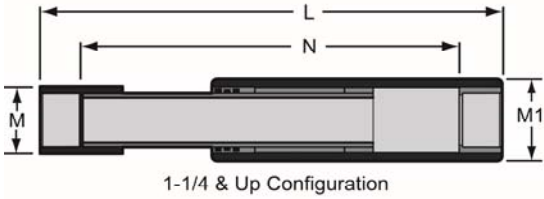

Expansion Joints Technical
Elastomer Expansion Joint Overview



Elastomer Expansion Joints allow for expansion, contraction, lateral and angular movement in piping systems. Ideal for use on pumps, chillers, cooling towers, etc., to absorb pipe movement and stress, compensate for minor misalignment and offset, aid in system noise reduction and vibration dampening, and to help protect against start-up surge forces. Features reinforced Double-Arched tube design in chemically resistant Neoprene or optional EPDM elastomers. Produced in IPS sizes 3/4" through 3" with PVC or CPVC Union end connections in Socket or Spears® Patented Special Reinforced (SR) Female Plastic Threads for convenient, reliable installations.

PVC or CPVC & Bonded Elastomer Construction

Constructed from corrosion resistant PVC or higher temperature handling CPVC with high-pressure molded elastomer tube for optimum chemical and corrosion resistance. Never rusts, scales or pits. Select from standard Neoprene or optional EPDM elastomer tube bellows.

Double Spherical Arch, Reinforced Tube

Wide Spherical Double-Arched design provides maximum movement capability in lateral deflection, angular misalignment, axial compression and extension. Special 3-layer construction features internal polyester cord reinforcement bonded within the elastomer so that no reinforcement material will be exposed to atmosphere or media. Maintains high strength while allowing thinner wall for greater flexibility.

Convenient Double Union (True Union) Connectors

Double union design with strong Buttress thread union nuts allows easy servicing and replacement. Available in Socket or Spears® patented Special Reinforced (SR) Female Plastic Threaded End Connectors.

Pressure Rated to 150 psi, Plus Vacuum Service

The inherent design strength of the spherical arch allows for full 150 psi pressure rating for water at 73°F (pressure de-ratings apply at elevated temperatures). The spherical arch design and the reinforcing material combine to provide for full vacuum service capability.

Sample Engineering Specifications

Elastomer Expansion Joints shall be elastomer tube design with double-union end connectors. Elastomer tubes shall be double spherical arch constructed from reinforced Neoprene or EPDM. All unions shall be constructed from PVC or CPVC with Buttress threaded Union Nuts and choice of Socket or Special Reinforced (SR) plastic threaded connections. All Elastomer Expansion Joints shall be pressure rated to 150 psi for water @ 73°, as manufactured by Spears® Manufacturing Company.



Expansion Joints Technical Elastomer Expansion Joint Overview

Technical Information

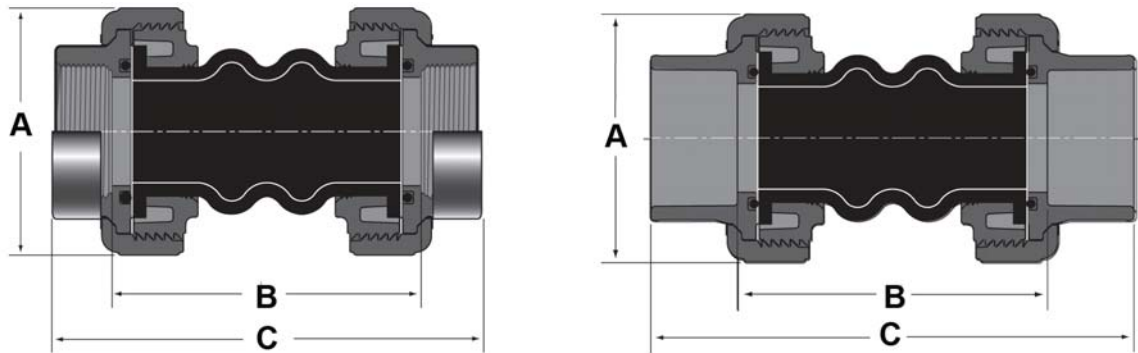

Dimensions (inches)

Size	A	B		C		MAXIMUM MOVEMENTS			
		Socket	Threaded	Socket	Threaded	COMPRESSION	EXTENSION	LATERAL	ANGULAR
3/4	2-1/4	6-7/8	7	8-7/8	8-5/16	7/8	1/4	7/8	35°
1	2-9/16	6-5/8	6-13/16	8-15/16	8-1/2	7/8	1/4	7/8	25°
1-1/4	3-1/8	6-1/2	6-11/16	9	8-7/16	7/8	1/4	7/8	25°
1-1/2	3-9/16	6-5/8	6-3/4	9-7/16	8-9/16	7/8	1/4	7/8	20°
2	4-3/16	6-1/4	6-3/8	9-5/16	8-1/4	7/8	1/4	7/8	15°
2-1/2	6-1/8	6-1/4	6-5/16	9-3/16	9	7/8	1/4	7/8	15°
3	6-1/8	6-3/16	6-3/16	10	9	7/8	1/4	7/8	15°

Maximum specified movements are non-concurrent.

General Specifications

Materials:

Union components - PVC/CPVC
Elastomers - Neoprene Tube Bellows/ Nitrile O-ring seal
EPDM Tube Bellows/ EPDM O-ring seal

Pressure Rating:

150 psi @ 73° F (1.03 MPa @23° C)

Vacuum Service:

Rated @ 26 in-Hg (88 kPa)

Maximum Service Temperature:

PVC = 140° F (60° C)

CPVC = 200° F (93° C)

Note: Pressure de-ratings apply at elevated temperatures.

Installation Considerations

Piping system must be properly aligned and anchored to prevent damage to an expansion joint of system components. Movement must not exceed maximum specified capacities.

For equipment isolation: Install Elastomer Expansion Joints just before and after the equipment generating the vibration. While vertical and perpendicular installation may be used, for optimum performance install horizontally and parallel to any rotating equipment shaft. For maximum vibration transmission reduction, the piping section beyond the rubber connector must be anchored.

Warning: Excessive noise and vibration may indicate severe problems in system design, operation, or support that cannot be compensated for through use of dampening devices. Such severe problems may also damage union components. Specific application and suitability must be evaluated and determined by the end user.

Expansion Joints Technical
Expansion Joint Dimensions



**ELASTOMER EXPANSION JOINT
 WITH NEOPRENE BELLOWS**

SOCKET x SOCKET

150 psi @ 73°F

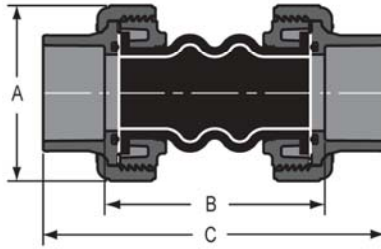

Part Number		Size	A	B	C	MAXIMUM MOVEMENTS				Approx. Wt. (LBS.)	
PVC	CPVC					COMPRESSION	EXTENSION	LATERAL	ANGULAR	PVC	CPVC
EJ02-007	--	3/4	2-1/4	6-3/8	8-3/8	7/8	1/4	7/8	35°	.50	---
EJ02-010	--	1	2-9/16	5-15/16	8-3/16	7/8	1/4	7/8	25°	.71	---
EJ02-012	--	1-1/4	3-1/8	6-1/16	8-9/16	7/8	1/4	7/8	25°	.70	---
EJ02-015	--	1-1/2	3-9/16	5-7/8	8-5/8	7/8	1/4	7/8	20°	1.07	---
EJ02-020	--	2	4-3/16	5-7/16	8-7/16	7/8	1/4	7/8	15°	1.54	---
EJ02-025	--	2-1/2	6-1/8	6-3/16	9-3/4	7/8	1/4	7/8	15°	4.49	---
EJ02-030	--	3	6-1/8	6-3/16	10	7/8	1/4	7/8	15°	4.71	---

**ELASTOMER EXPANSION JOINT
 WITH EPDM BELLOWS**

SOCKET x SOCKET

150 psi @ 73°F

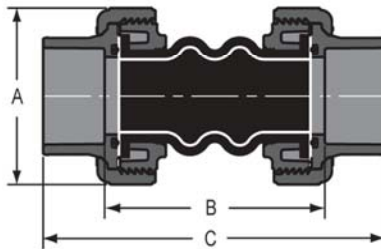

Part Number		Size	A	B	C	MAXIMUM MOVEMENTS				Approx. Wt. (LBS.)	
PVC	CPVC					COMPRESSION	EXTENSION	LATERAL	ANGULAR	PVC	CPVC
EJ02-007	EJ02-007C	3/4	2-1/4	6-3/8	8-3/8	7/8	1/4	7/8	35°	.32	.39
EJ02-010	EJ02-010C	1	2-9/16	5-15/16	8-3/16	7/8	1/4	7/8	25°	.70	.81
EJ02-012	EJ02-012C	1-1/4	3-1/8	6-1/16	8-9/16	7/8	1/4	7/8	25°	.81	.84
EJ02-015	EJ02-015C	1-1/2	3-9/16	5-7/8	8-5/8	7/8	1/4	7/8	20°	1.03	1.07
EJ02-020	EJ02-020C	2	4-3/16	5-7/16	8-7/16	7/8	1/4	7/8	15°	1.54	1.61
EJ02-025	EJ02-025C	2-1/2	6-1/8	6-3/16	9-3/4	7/8	1/4	7/8	15°	4.49	4.77
EJ02-030	EJ02-030C	3	6-1/8	6-3/16	10	7/8	1/4	7/8	15°	4.81	5.04



Expansion Joints Technical Expansion Joint Dimensions

ELASTOMER EXPANSION JOINT WITH NEOPRENE BELLOWS

SR Fipt x SR Fipt

150 psi @ 73°F

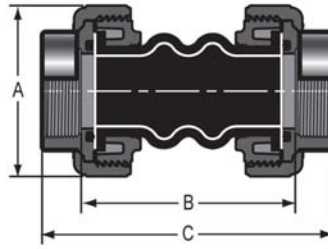

Part Number		Size	A	B	C	MAXIMUM MOVEMENTS				Approx. Wt. (LBS.)	
PVC	CPVC					COMPRESSION	EXTENSION	LATERAL	ANGULAR	PVC	CPVC
EJ01-007SR	--	3/4	2-1/4	6-3/8	7-3/16	7/8	1/4	7/8	35°	.51	---
EJ01-010SR	--	1	2-9/16	6	7-3/4	7/8	1/4	7/8	25°	.73	---
EJ01-012SR	--	1-1/4	3-1/8	6-1/16	7-15/16	7/8	1/4	7/8	25°	.73	---
EJ01-015SR	--	1-1/2	3-9/16	5-7/8	7-3/4	7/8	1/4	7/8	20°	1.15	---
EJ01-020SR	--	2	4-3/16	5-7/16	7-3/8	7/8	1/4	7/8	15°	1.58	---
EJ01-025SR	--	2-1/2	6-1/8	6-3/16	9	7/8	1/4	7/8	15°	4.63	---
EJ01-030SR	--	3	6-1/8	6-3/16	9	7/8	1/4	7/8	15°	4.84	---

ELASTOMER EXPANSION JOINT WITH EPDM BELLOWS

SR Fipt x SR Fipt

150 psi @ 73°F

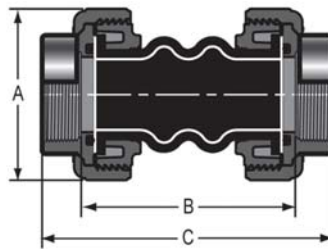

Part Number		Size	A	B	C	MAXIMUM MOVEMENTS				Approx. Wt. (LBS.)	
PVC	CPVC					COMPRESSION	EXTENSION	LATERAL	ANGULAR	PVC	CPVC
EJ21-007SR	EJ21-007CSR	3/4	2-1/4	6-3/8	7-3/16	7/8	1/4	7/8	35°	.33	.39
EJ21-010SR	EJ21-010CSR	1	2-9/16	6	7-3/4	7/8	1/4	7/8	25°	.71	.83
EJ21-012SR	EJ21-012CSR	1-1/4	3-1/8	6-1/16	7-15/16	7/8	1/4	7/8	25°	.74	.76
EJ21-015SR	EJ21-015CSR	1-1/2	3-9/16	5-7/8	7-3/4	7/8	1/4	7/8	20°	1.15	1.19
EJ21-020SR	EJ21-020CSR	2	4-3/16	5-7/16	7-3/8	7/8	1/4	7/8	15°	1.58	1.65
EJ21-025SR	EJ21-025CSR	2-1/2	6-1/8	6-3/16	9	7/8	1/4	7/8	15°	4.63	4.91
EJ21-030SR	EJ21-030CSR	3	6-1/8	6-3/16	9	7/8	1/4	7/8	15°	4.85	5.19

Expansion Joints Technical
Expansion Joint Dimensions



Fabricated Expansion Joints

6" Travel with EPDM O-rings
 1/2" - 2" 235 psi @ 73°F (23°C) 2-1/2" - 12" 150
 psi @ 73°F (23°C) 14" 100 psi @ 73°F (23°C)

T = TRAVEL

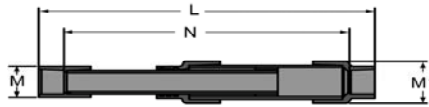

Part Number	Size	L-Closed	L-Open	M	M1	N-Closed	N-Open	T	Approx. Wt. (Lbs.)
826-005X6*	1/2	10-9/16	16-9/16	1-3/16	1-3/4	8-13/16	14-13/16	6	.59
826-007X6*	3/4	12	18	1-7/16	2-1/8	10	16	6	.83
826-010X6*	1	12-1/2	18-1/2	1-5/8	2-3/8	10-1/4	16-1/4	6	1.36
826-012X6*	1-1/4	13-1/16	19-1/16	2-1/4	2-3/8	10-1/2	16-1/2	6	1.70
826-015X6*	1-1/2	13-1/4	19-1/4	2-3/8	2-7/8	10-7/16	16-7/16	6	2.60
826-020X6*	2	14-7/16	20-7/16	2-7/8	3-1/2	11-7/16	17-7/16	6	3.91
826-025X6*	2-1/2	16-1/4	22-1/4	4-3/16	4-1/2	12-3/4	18-3/4	6	6.42
826-030X6*	3	15-5/8	21-5/8	4-3/16	4-1/2	11-13/16	17-13/16	6	5.61
826-040X6*	4	16-15/16	22-15/16	5-1/4	5-9/16	12-9/16	18-9/16	6	11.51
826-060X6*	6	19-3/4	25-3/4	7-9/16	8-5/8	13-5/8	19-5/8	6	25.13
826-080X6*	8	24-1/2	30-1/2	9-11/16	10-3/4	16-9/16	22-9/16	6	44.67
826-100X6*	10	28-7/8	34-7/8	12-1/16	12-3/4	18-7/8	24-7/8	6	81.75
826-120X6*	12	34	40	14-1/4	16	22	28	6	140.40
826-140X6*	14	40-3/4	46-3/4	15-1/2	16	26	32	6	146.76

FKM O-rings available on special order. Add a "V" preceding the dash (-) separator, e.g. 826V-005X6.

* Fabricated

Fabricated Expansion Joints

12" Travel with EPDM O-rings
 1/2" - 2" 235 psi @ 73°F (23°C) 2-1/2" - 12" 150
 psi @ 73°F (23°C) 14" 100 psi @ 73°F (23°C)

T = TRAVEL

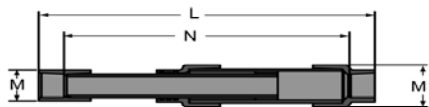

Part Number	Size	L-Closed	L-Open	M	M1	N-Closed	N-Open	T	Approx. Wt. (Lbs.)
826-005X12*	1/2	16-9/16	28-9/16	1-3/16	1-3/4	14-13/16	26-13/16	12	.93
826-007X12*	3/4	18	30	1-7/16	2-1/8	16	28	12	1.29
826-010X12*	1	18-1/2	30-1/2	1-5/8	2-3/8	16-1/4	28-1/4	12	1.79
826-012X12*	1-1/4	19-1/16	31-1/16	2-1/4	2-3/8	16-1/2	28-1/2	12	2.28
826-015X12*	1-1/2	19-1/4	31-1/4	2-3/8	2-7/8	16-7/16	28-7/16	12	3.66
826-020X12*	2	20-7/16	32-7/16	2-7/8	3-1/2	17-7/16	29-7/16	12	5.28
826-025X12*	2-1/2	22-1/4	34-1/4	4-3/16	4-1/2	18-3/4	30-3/4	12	8.23
826-030X12*	3	21-5/8	33-5/8	4-3/16	4-1/2	17-13/16	29-13/16	12	7.39
826-040X12*	4	22-15/16	34-15/16	5-1/4	5-9/16	18-9/16	30-9/16	12	15.54
826-060X12*	6	25-3/4	37-3/4	7-9/16	8-5/8	19-5/8	31-5/8	12	32.20
826-080X12*	8	30-1/2	42-1/2	9-11/16	10-3/4	22-9/16	34-9/16	12	55.11
826-100X12*	10	34-7/8	46-7/8	12-1/16	12-3/4	24-7/8	36-7/8	12	96.11
826-120X12*	12	40	52	14-1/4	16	28	40	12	175.79



Expansion Joints Technical Expansion Joint Dimensions

Fabricated Expansion Joints

(Continued)

12" Travel with EPDM O-rings
 1/2" - 2" 235 psi @ 73°F (23°C) 2-1/2" - 12" 150
 psi @ 73°F (23°C) 14" 100 psi @ 73°F (23°C)

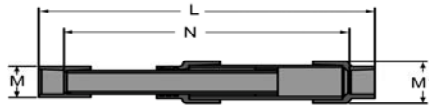

T = TRAVEL

Part Number	Size	L-Closed	L-Open	M	M1	N-Closed	N-Open	T	Approx. Wt. (Lbs.)
826-140X12*	14	46-3/4	58-3/4	15-1/2	16	32	44	12	164.81

FKM O-rings available on special order. Add a "V" preceding the dash (-) separator, e.g. 826V-005X12

* Fabricated

Fabricated Expansion Joints

6" Travel with FKM O-rings
 1/2" - 2" 235 psi @ 73°F (23°C) 2-1/2" - 12" 150
 psi @ 73°F (23°C) 14" 100 psi @ 73°F (23°C)

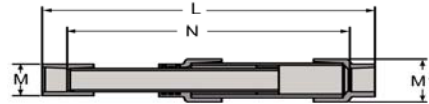

T = TRAVEL

Part Number	Size	L-Closed	L-Open	M	M1	N-Closed	N-Open	T	Approx. Wt. (Lbs.)
826-005X6C*	1/2	10-9/16	16-9/16	1-3/16	1-3/4	8-13/16	14-13/16	6	.77
826-007X6C*	3/4	12	18	1-7/16	2- 1/8	10	16	6	1.07
826-010X6C*	1	12-1/2	18-1/2	1-5/8	2-3/8	10-1/14	16-1/4	6	1.44
826-012X6C*	1-1/4	13-1/16	19-1/16	2-1/4	2- 3/8	10-1/2	16-1/2	6	1.82
826-015X6C*	1-1/2	13-1/4	19-1/4	2-3/8	2- 7/8	10-7/16	16-7/16	6	2.67
826-020X6C*	2	14-7/16	20-7/16	2- 7/8	3- 1/2	11-7/16	17-7/16	6	4.10
826-025X6C*	2-1/2	16-1/4	22-1/4	4- 3/16	4- 1/2	12-3/4	18-3/4	6	6.82
826-030X6C*	3	15-5/8	21-5/8	4- 3/16	4- 1/2	11-13/16	17-13/16	6	5.98
826-040X6C*	4	16-15/16	22-15/16	5-1/4	5- 9/16	12-9/16	18-9/16	6	8.90
826-060X6C*	6	19-3/4	25-3/4	7-9/16	8- 5/8	13-5/8	19-5/8	6	31.13
826-080X6C*	8	24-1/2	30-1/2	9-11/16	10- 3/4	16-9/16	22-9/16	6	46.59
826-100X6C*	10	28-7/8	34-7/8	12-1/16	12- 3/4	18-7/8	24-7/8	6	90.88
826-120X6C*	12	34	40	14-1/4	16	22	28	6	158.72
826-140X6C*	14	40-3/4	46-3/4	15-1/2	16	26	32	6	172.37

EPDM O-rings available on special order. Add an "E" preceding the dash (-) separator, e.g. 826E-005X6C

* Fabricated

Expansion Joints Technical
Expansion Joint Dimensions



Fabricated Expansion Joints

12" Travel with FKM O-rings
1/2" - 2" 235 psi @ 73°F (23°C) 2-1/2" - 12" 150 psi @ 73°F (23°C) 14" 100 psi @ 73°F (23°C)

T = TRAVEL



Part Number	Size	L-Closed	L-Open	M	M1	N-Closed	N-Open	T	Approx. Wt. (Lbs.)
826-005X12C*	1/2	16-9/16	28-9/16	1-3/16	1-3/4	14-13/16	26-13/16	12	1.04
826-007X12C*	3/4	18	30	1-7/16	2- 1/8	16	28	12	1.43
826-010X12C*	1	18-1/2	30-1/2	1-5/8	2-3/8	16-1/4	28-1/4	12	1.90
826-012X12C*	1-1/4	19-1/16	31-1/16	2-1/4	2- 3/8	16-1/2	28-1/2	12	2.44
826-015X12C*	1-1/2	19-1/4	31-1/4	2-3/8	2- 7/8	16-7/16	28-7/16	12	3.74
826-020X12C*	2	20-7/16	32-7/16	2- 7/8	3- 1/2	17-7/16	29-7/16	12	5.54
826-025X12C*	2 -1/2	22-1/4	34-1/4	4- 3/16	4- 1/2	18-3/4	30-3/4	12	8.73
826-030X12C*	3	21-5/8	33-5/8	4- 3/16	4- 1/2	17-13/16	29-13/16	12	7.89
826-040X12C*	4	22-15/16	34-15/16	5-1/4	5- 9/16	18-9/16	30-9/16	12	11.20
826-060X12C*	6	25- 3/4	37-3/4	7-9/16	8- 5/8	19-5/8	31-5/8	12	40.24
826-080X12C*	8	30-1/2	42-1/2	9-11/16	10- 3/4	22-9/16	34-9/16	12	57.62
826-100X12C*	10	34-7/8	46-7/8	12-1/16	12- 3/4	24-7/8	36-7/8	12	106.56
826-120X12C*	12	40	52	14-1/4	16	28	40	12	215.79
826-140X12C*	14	46-3/4	58-3/4	15-1/2	16	32	44	12	192.94

EPDM O-rings available on special order. Add an "E" preceding the dash (-) separator, e.g. 826E-005X12C

* Fabricated

Repair Coupling - Spigot x Socket

PVC White with EPDM O-ring
Can be used as short-stroke Expansion Joint

Pressure Rating
1/2'- 2" 235 psi @ 73° F
2-1/2" - 4" 200 psi @ 73° F
6" & up 150 psi @ 73 ° F



Part Number	Size	L	L2	L3	M	T	Approx. Wt. (Lbs.)
S118-05	1/2	11/16	6-3/8	5-11/16	1-7/16	3	.24
S118-07	3/4	3/4	7-11/16	6-15/16	1-11/16	4	.42
S118-10	1	31/32	8-1/2	7-1/2	2-1/16	4	.67
S118-12	1-1/4	1	8-3/4	7-3/4	2-3/8	4	.87
S118-15	1-1/2	1-3/32	9-3/16	8-1/16	2-11/16	4	1.02
S118-20	2	1-3/16	9-15/16	8-3/4	3-3/16	4	1.55
S118-25	2-1/2	1-27/32	13-5/8	11-3/4	3-15/16	6	3.63
S118-30	3	1-15/16	13-5/8	11-11/16	4-5/8	6	4.44
S118-40	4	2-5/16	14-7/8	12-9/16	5-11/16	6	6.64
S118-60	6	3-1/16	17-3/16	14-1/8	8-7/16	6	14.72

Unit Must Be Thrust Blocked



Expansion Joints Technical Expansion Joint Dimensions

Repair Coupling - Socket x Socket

PVC White with EPDM O-ring
Can be used as short-stroke Expansion Joint

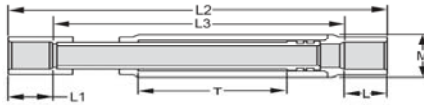

Pressure Rating
1/2" - 2" 235 psi @ 73° F
2-1/2" - 4" 200 psi @ 73° F
6" & up 150 psi @ 73° F

Part Number	Size	L	L1	L2	L3	M	T	Approx. Wt. (Lbs.)
S119-05	1/2	11/16	7/8	7-3/8	5-13/16	1-7/16	3	.28
S119-07	3/4	3/4	1	8-13/16	7-1/16	1-11/16	4	.47
S119-10	1	31/32	1-1/8	9-9/16	7-1/2	2-1/16	4	.75
S119-12	1-1/4	1	1-1/4	10-1/16	7-13/16	2-3/8	4	.98
S119-15	1-1/2	1-3/32	1-3/8	10-1/2	8-1/16	2-11/16	4	1.16
S119-20	2	1-3/16	1-1/2	11-1/2	8-3/4	3-3/16	4	1.77
S119-25	2-1/2	1-27/32	1-3/4	15-7/16	11-13/16	3-15/16	6	4.01
S119-30	3	1-15/16	1-7/8	15-5/8	11-13/16	4-5/8	6	4.98
S119-40	4	2-5/16	2-1/4	17-5/16	12-13/16	5-11/16	6	7.53
S119-60	6	3-1/16	3	20-1/2	14-7/16	8-7/16	6	17.74

Unit Must Be Thrust Blocked

Repair Coupling - Short, Spigot x Socket

PVC White with EPDM O-ring



Pressure Rating
235 psi @ 73° F

Part Number	Size	L	L2	L3	M	T	Approx. Wt. (Lbs.)
SH118-05	1/2	11/16	5	4-5/16	1-7/16	2	.19
SH118-07	3/4	3/4	5-1/2	4-3/4	1-3/4	2-1/4	.29
SH118-10	1	15/16	5-5/8	4-11/16	2-1/16	2	.39
SH118-12	1-1/4	1	6-1/2	5-1/2	2-7/16	2-1/2	.61
SH118-15	1-1/2	1-1/8	6-13/16	5-11/16	2-11/16	2-3/4	.76
SH118-20	2	1-3/16	8-3/16	7	3-3/16	3-1/4	1.19

Unit Must Be Thrust Blocked

Expansion Joints Technical
Expansion Joint Dimensions



**Repair Coupling - Short,
 Socket x Socket**

PVC White with EPDM O-ring

Pressure Rating
 235 psi @ 73° F



Part Number	Size	L	L1	L2	L3	M	T	Approx. Wt. (Lbs.)
SH119-05	1/2	11/16	7/8	6	4-3/8	1-7/16	2	.22
SH119-07	3/4	3/4	1	6-9/16	4-13/16	1-3/4	2	.34
SH119-10	1	15/16	1-1/8	6-13/16	4-3/4	2-1/16	2	.47
SH119-12	1-1/4	1	1-1/4	7-7/8	5-9/16	2-7/16	2-1/2	.72
SH119-15	1-1/2	1-1/2	1-3/8	8-3/16	5-11/16	2-11/16	2-3/4	.90
SH119-20	2	1-3/16	1-1/2	9-13/16	7-1/16	3-3/16	3-1/4	1.41
S119-25	2-1/2	1-27/32	1-3/4	15-7/16	11-13/16	3-15/16	6	4.01
S119-30	3	1-15/16	1-7/8	15-5/8	11-13/16	4-5/8	6	4.98
S119-40	4	2-5/16	2-1/4	17-5/16	12-13/16	5-11/16	6	7.53
S119-60	6	3-1/16	3	20-1/2	14-7/16	8-7/16	6	17.74

Unit Must Be Thrust Blocked

